



C - PS



C - GGC



C - FSV



C - TMBV



C - FBV

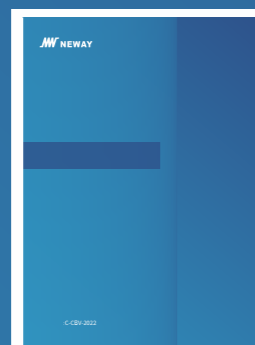

C - CBV



C - MMBV

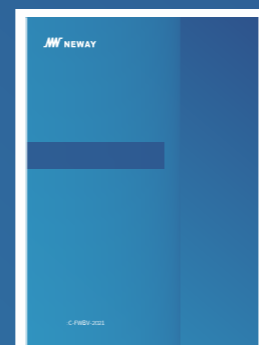

C - FWBV



C - BFV



C - DOV

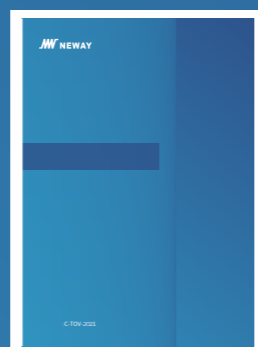

C - TOV



C - CPS

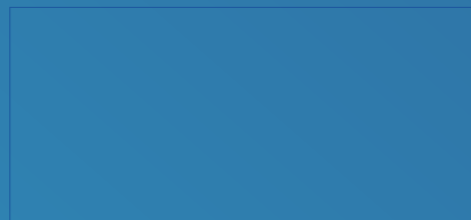

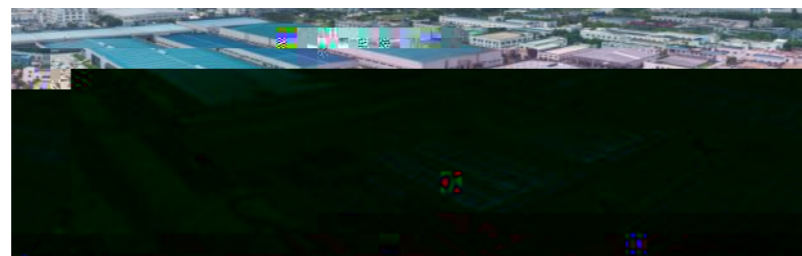

603699)

230,000

1 3 1 1  
 Ansys Fe-safe CF-design SiemensPLM NX

SAP

80

ISO API

ISO 9001 , API 6A, API 6D, API 600  
 CE-PED AD2000 TA-Luft,  
 API 624, ISO 15848 API 607, API 6FA

SIL



▼

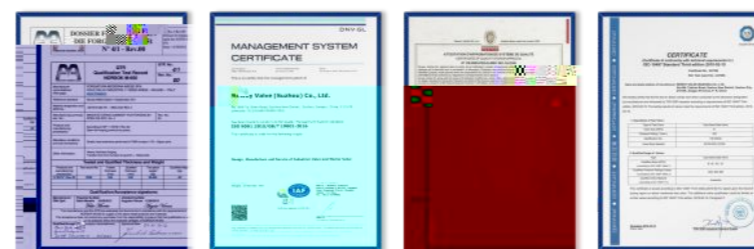

NORSOK ISO 9001 CE/PED

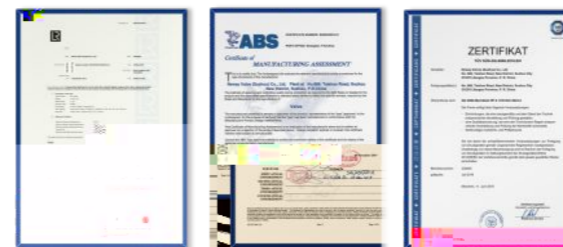

TA Luft ABS AD2000

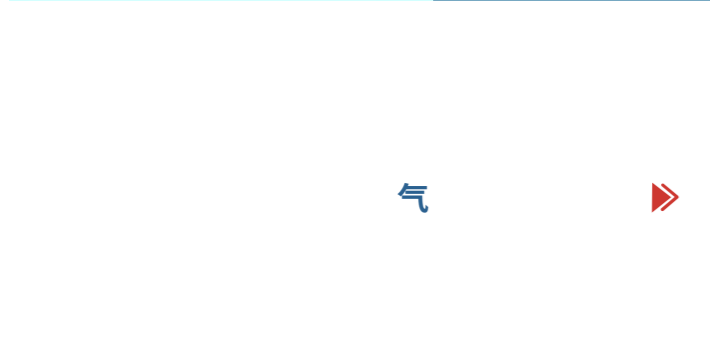

气



ALMIRANTE TAMANDARE - FPSO



M



LNG

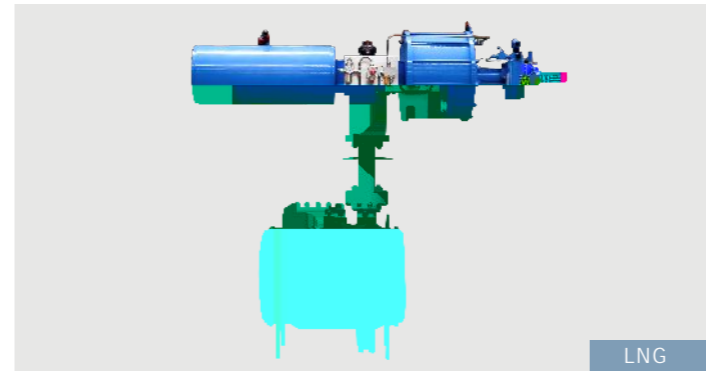

LNG



LNG



40



150





# 设计特色

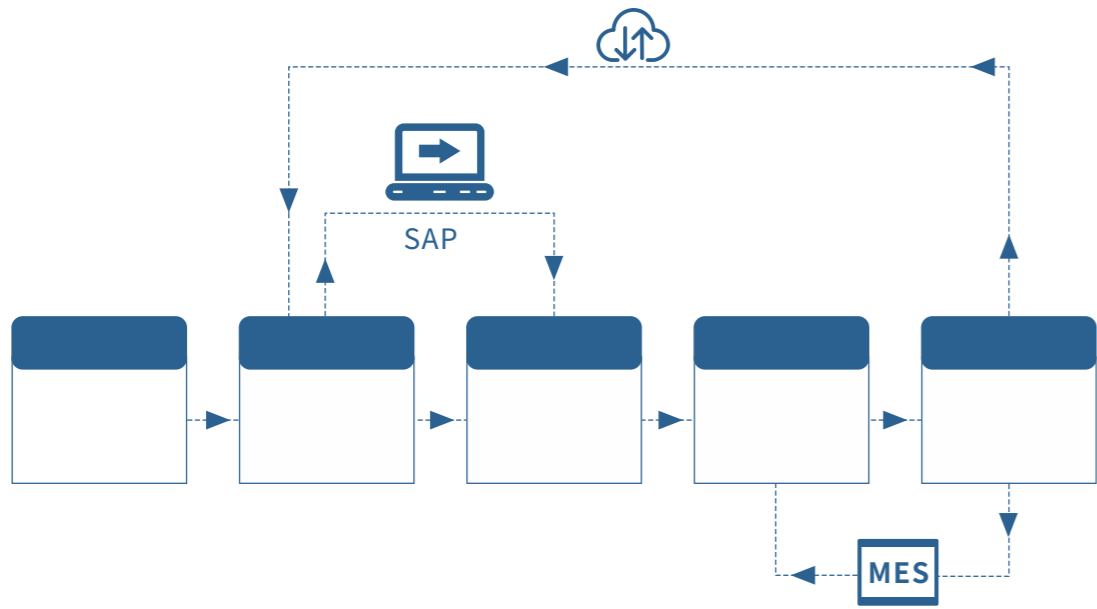
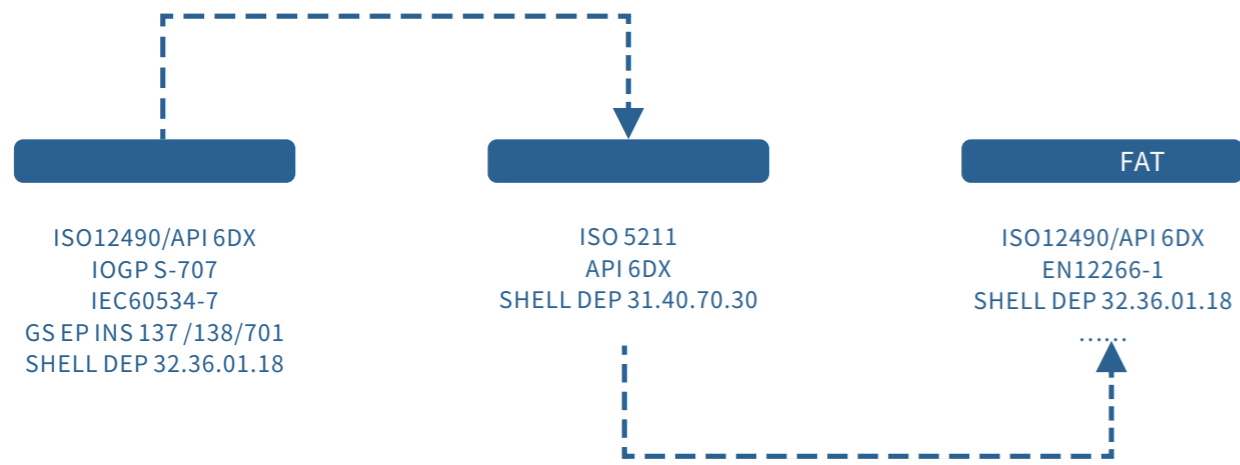

## • DAL

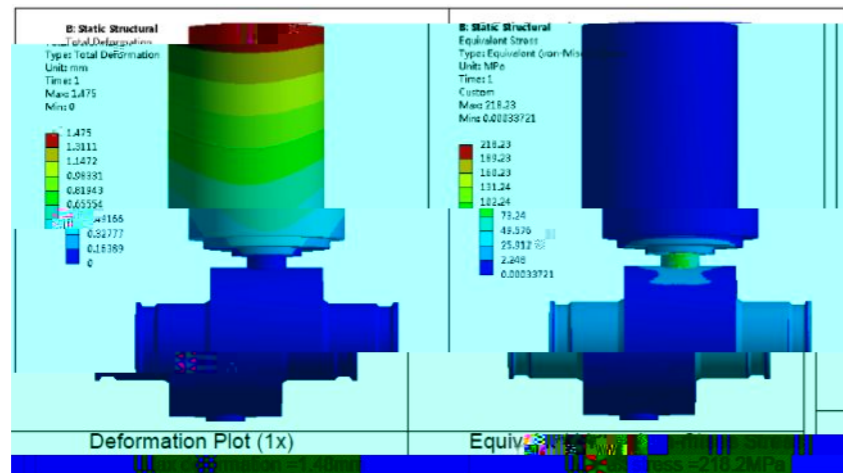

# 设计特色

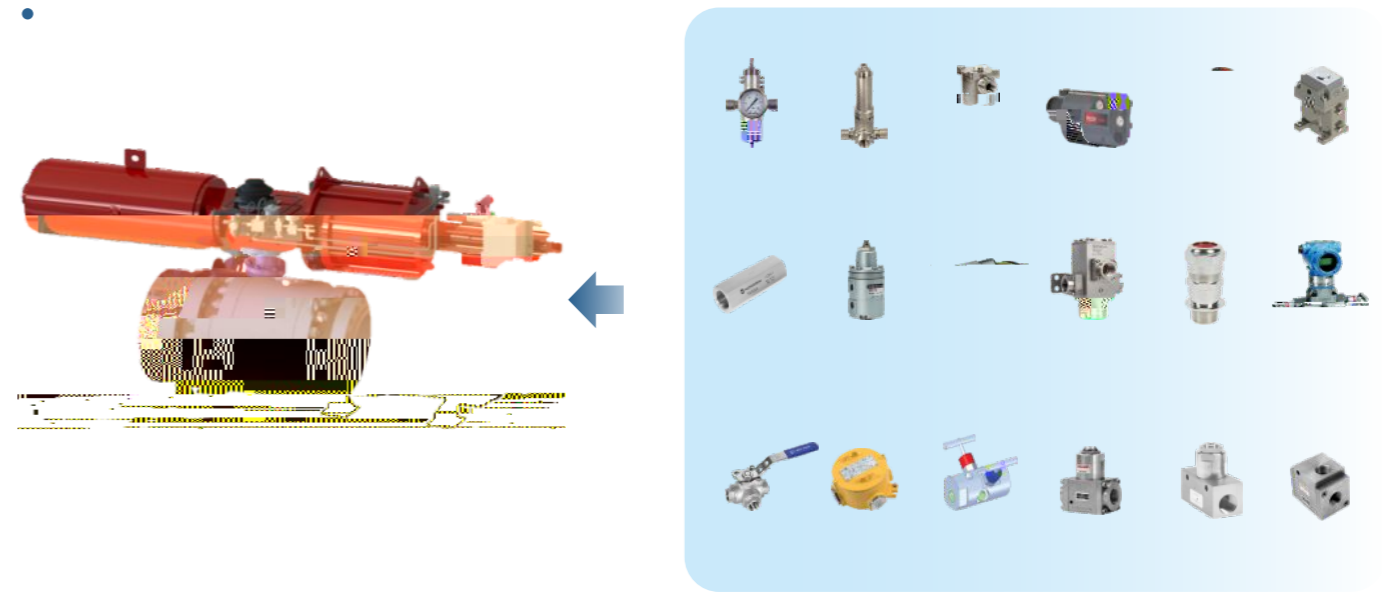

316SS  
316SS, 904SS, 6mo  
316SS, 904SS, 6mo

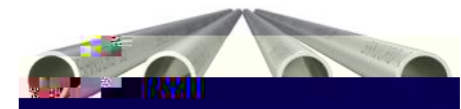

## • (PST)

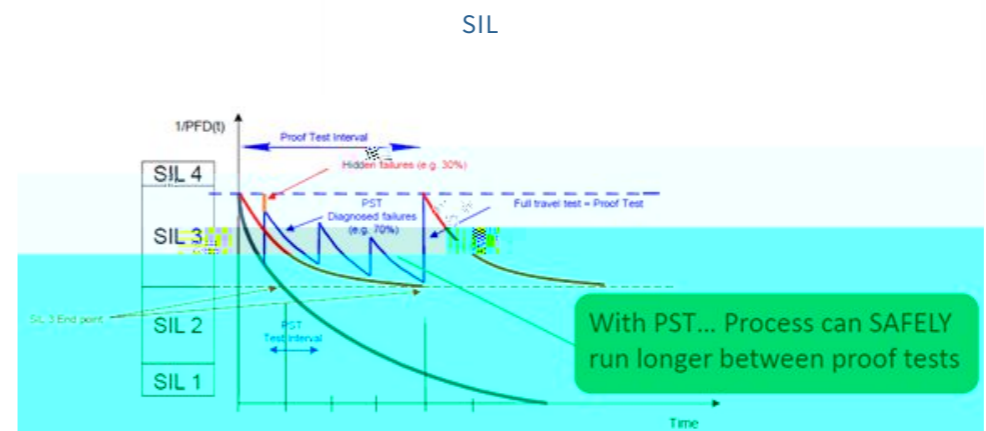



- 
- ▶
- ▶
- ▶
- ▶
- ▶
- ▶
- ▶
- ▶

1/2"~10"(DN10~DN300)
Class 150~2500(PN16~PN420)
-196~425°C

- 
- ▶ ▶ -
- ▶ ▶ -
- ▶ ▶ -

- 
- ▶
- ▶ ESDV)
- ▶ MOV)
- ▶
- ▶
- ▶

- 
- ▶
- ▶
- ▶
- ▶
- ▶
- ▶



- 
- ▶
- ▶
- ▶
- ▶
- ▶
- ▶
- ▶

2"~60"(DN50~DN1500)
Class150~2500(PN16~PN420)
-196~425°C

- 
- ▶ ▶ -
- ▶ ▶ -
- ▶ ▶ -

- 
- ▶
- ▶ ESDV)
- ▶ MOV)
- ▶
- ▶
- ▶

- 
- ▶
- ▶ LNG
- ▶

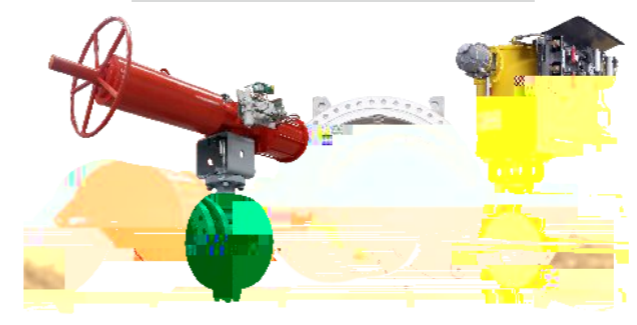

- 
- ▶
- ▶
- ▶
- ▶
- ▶
- ▶
- ▶
- ▶
- ▶

2"~160"(DN50~DN4000)
Class 150~2500(PN16~PN420)
-253~816

- 
- ▶ ▶ -
- ▶ ▶ -
- ▶ ▶ -

- 
- ▶
- ▶ ESDV)
- ▶ MOV)
- ▶
- ▶
- ▶

- 
- ▶
- ▶ &
- ▶
- ▶
- ▶
- ▶
- ▶ LNG

HIPPS /HIPPS



• HIPPS



- 
- ▶
- ▶
- ▶

- ▶ SIL3
- ▶ 2s
- ▶
- 
- ▶ API 170
- ▶ API RP 14B
- ▶ API RP 14C
- ▶ SHELL DEP 32.80.10.10
- ▶ PDO SP-2354

- 
- ▶ ▶ -
- ▶ ▶ -
- ▶ ▶ -

- 
- ▶
- ▶ Off-shore
- ▶ On-shore
- ▶
- ▶ LNG
- ▶



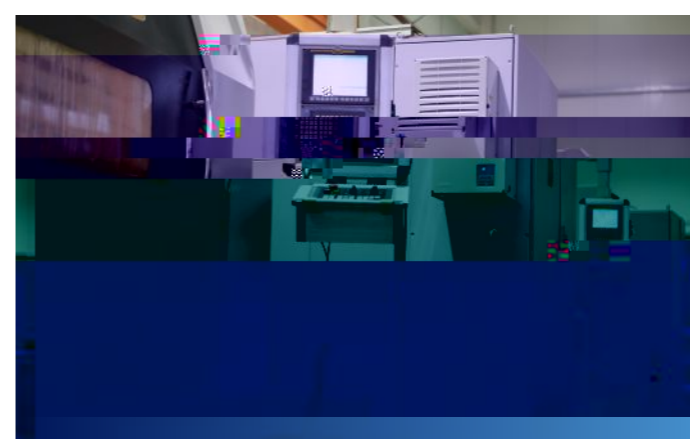
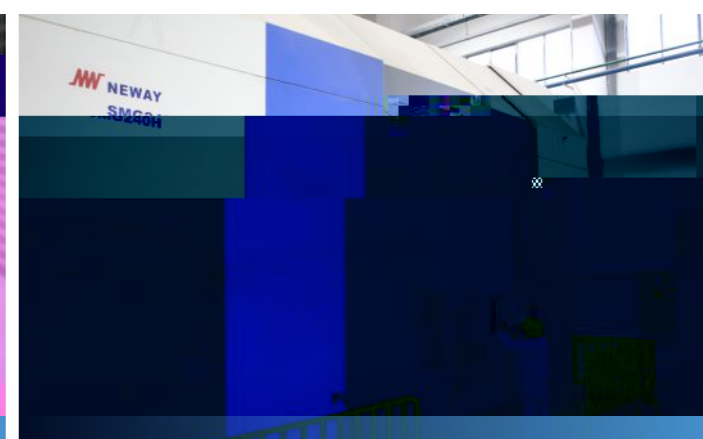
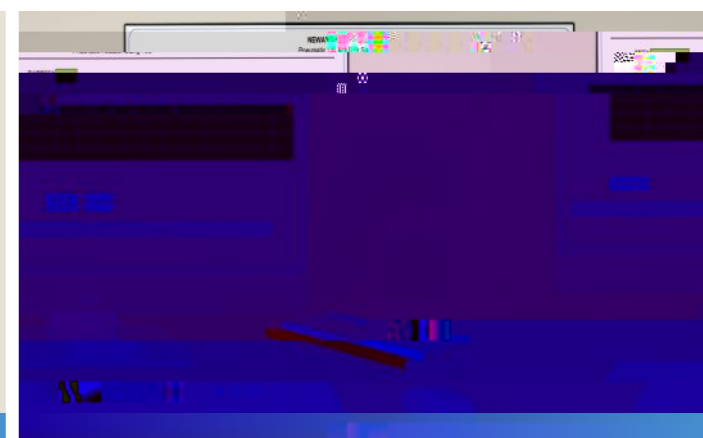
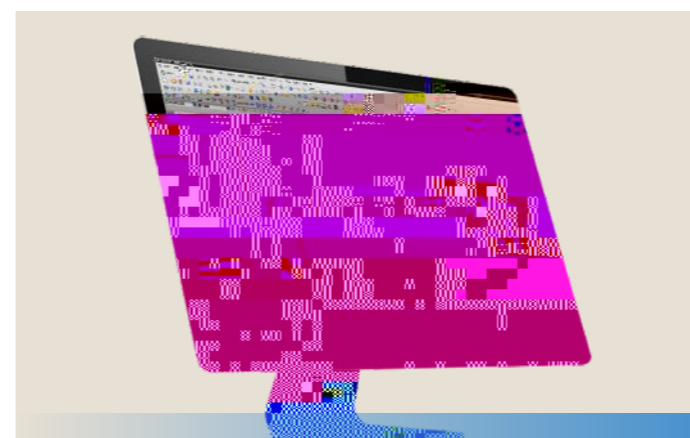
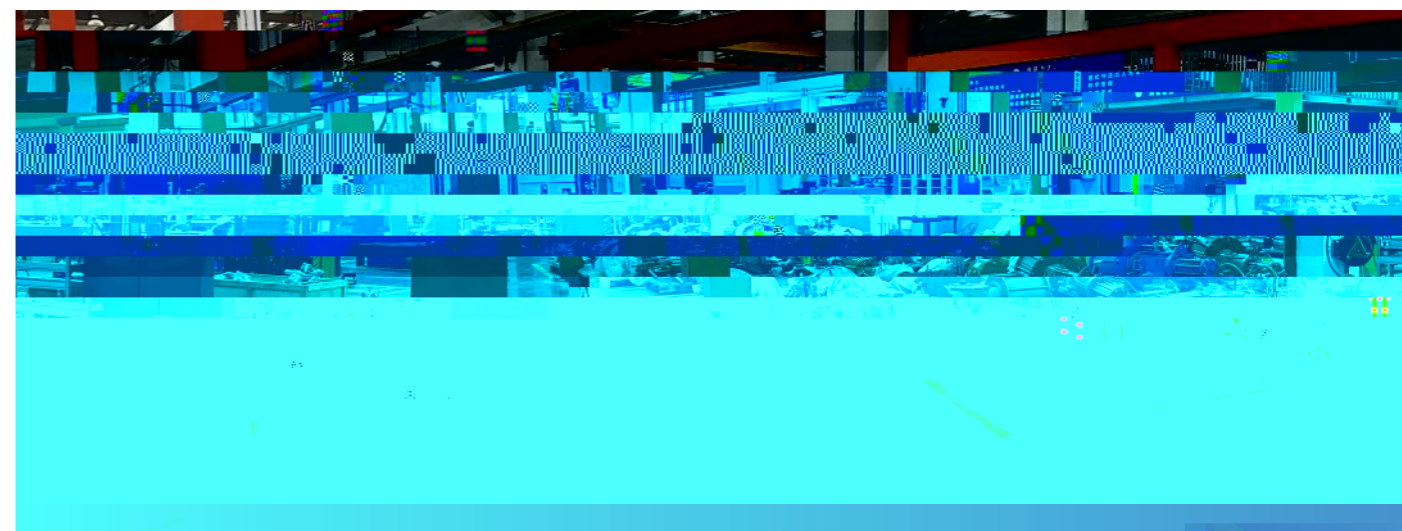
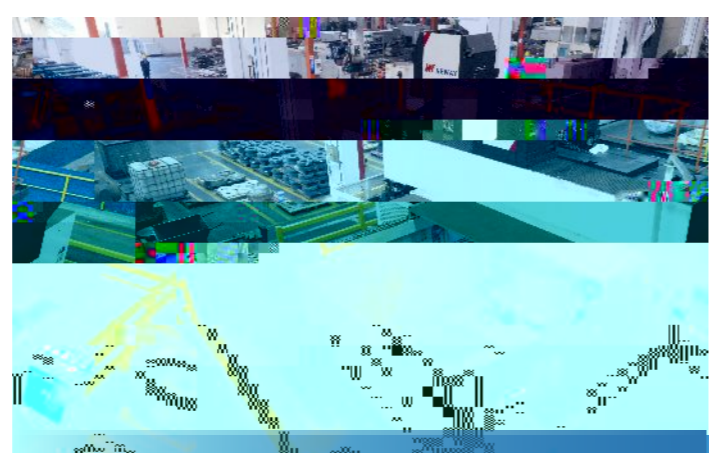
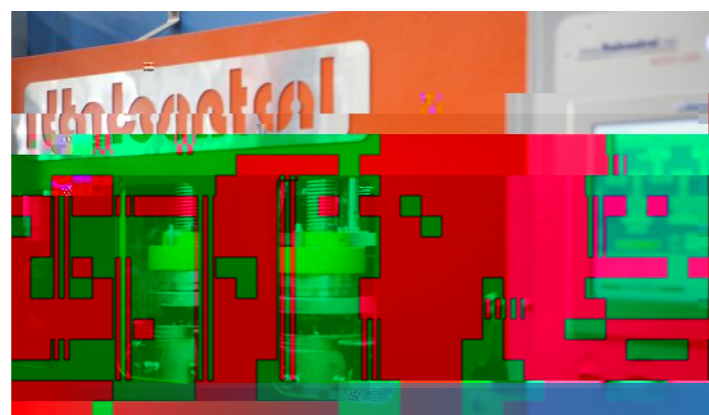

仪控阀近三年业绩一览

Damper of 7th GSP PROJECT		8"~102"	150LB
90	PDH	8"~96"	300LB
	(LNG)	8"~40"	150LB
45	/	8"~40"	150LB~600LB
2000		8"~28"	150LB
12	FLNG	8"~28"	150LB~600LB
9-7	19-1	8"~24"	300LB
		8"~24"	150LB~300LB
		8"~16"	150LB
		8"~16"	150LB
LNG PIPELINE VALVES		8"~24"	600LB
		8"~14"	150LB
LNG		6"~32"	600LB
19		6"~28"	300LB~900LB
150		6"~20"	300LB~600LB
		6"~16"	300LB
10 FGSS		6"	150LB
		4"~36"	150LB~1500LB
QKMJSEC		2.5"~36"	150LB
Mariana	2	8"~26"	150LB
		8"~12"	150LB
10	DMF.10	8"	150LB
480	/	3/4"~1"	150LB~300LB
		12"~14"	300LB~900LB
LNG		1-1/2"~6"	150LB~900LB
1.5	LNG	1"~5"	150LB
40	60 20	1"~12"	150LB~900LB
237B		3/4"~10"	150LB
5500 LPGNH3VCM		1/2"~3"	150LB~300LB
120		8"~44"	150LB~600LB
		8"~28"	150LB~300LB
		8"~24"	150LB~2500LB
560	/	8"~16"	150LB~2500LB
		8"~16"	2500LB
		8"	1500LB
		6"~8"	150LB~300LB
12		2-1/2"~32"	150LB~300LB
		8"	300LB
		5"~6"	600LB
BDO		4"~10"	2500LB~4500LB
		3"~6"	300LB
		2"~4"	300LB
		6"~28"	2500LB
2X60		2"~4"	150LB~600LB
220	/	3/4"~12"	900LB~1500LB
		3/4"~1"	800LB~1500LB
		4"	300LB
15		3"	150LB

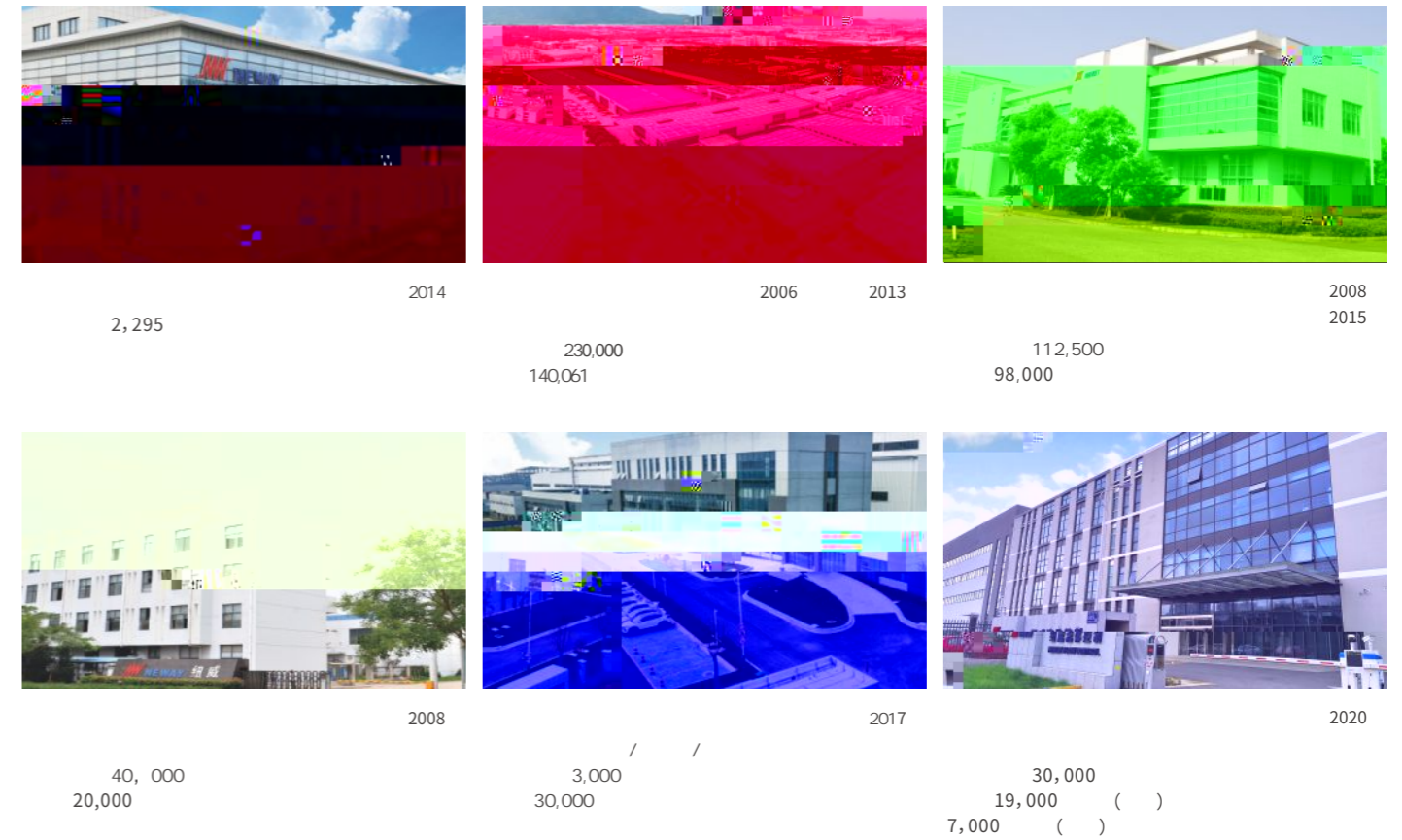

产品质量担保

